

### 描述 / Descriptions

TO-92 塑封封装电压调整器。Voltage Regulator in a TO-92 Plastic Package.

### 特征 / Features

三端稳压调整器，输出电流高达 100mA,内设过热保护和短路限制。

3-Terminal regulators ,output current up to 100 mA, internal thermal overload protection and short-circuit limiting.

### 用途 / Applications

电压调整器。

Voltage Regulator.

### 内部等效电路/应用电路 / Equivalent Circuit or Application Circuit

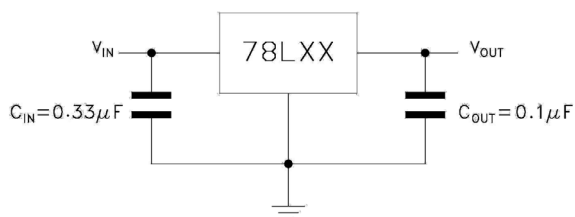

### 引脚排列 / Pinning



PIN 1 : IN

PIN 2 : GND

PIN 3 : OUT

### 印章代码 / Marking

见印章说明。See Marking Instructions

**极限参数 / Absolute Maximum Ratings(Ta=25°C)**

参数 Parameter	符号 Symbol	数值 Rating	单位 Unit
Input voltage	$V_I$	30	V
Output current	$I_O$	100	mA
Operating virtual Junction temperature	$T_J$	0~125	°C
Power Dissipation	$P_D$	500	mW
Storage temperature range	$T_{stg}$	-65~150	°C

**电性能参数 / Electrical Characteristics(Ta=25°C , Vi=11V,Io=40mA , unless otherwise specified)**

参数 Parameter	符号 Symbol	测试条件 Test Conditions	最小值 Min	典型值 Typ	最大值 Max	单位 Unit
Output voltage	$V_O$	$I_O=40mA$ $T_j=25^\circ C$	5.75	6.0	6.25	V
		$I_O=1mA$ to 40mA $V_I=8V$ to 20V	5.7	6.0	6.3	V
		$I_O=1mA$ to 70mA $V_I=11V$	5.7	6.0	6.3	V
Input regulation	$\Delta V_O$	$V_I=8V$ to 20V $T_j=25^\circ C$		35	150	mV
		$V_I=9V$ to 20V $T_j=25^\circ C$		29	100	mV
Ripple rejection	RR	$V_I=9V$ to 19V $f=120Hz$ $T_j=25^\circ C$	40	48		dB
Output regulation	$\Delta V_O$	$I_O=1mA$ to 100mA $T_j=25^\circ C$		16	60	mV
		$I_O=1mA$ to 40Ma $T_j=25^\circ C$		9	30	mV
Output noise voltage	$V_N$	$f=10Hz-100KHz$ $T_j=25^\circ C$		46		$\mu V$
Dropout voltage	$V_D$	$T_j=25^\circ C$		1.7		V
Bias current	$I_Q$	$T_j=25^\circ C$		3.9	6	mA
		$T_j=125^\circ C$			5.5	mA
Bias current change	$\Delta I_Q$	$V_I=9V$ to 20V			1.5	mA
		$I_O=1mA$ to 40mA			0.1	mA

电参数曲线图 / Electrical Characteristic Curve

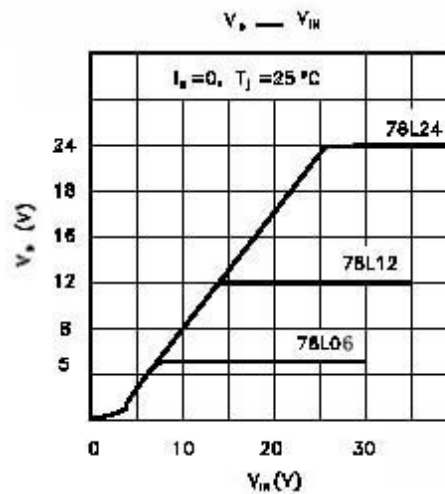
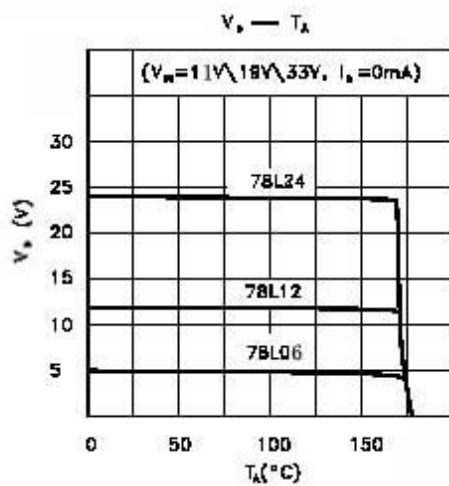
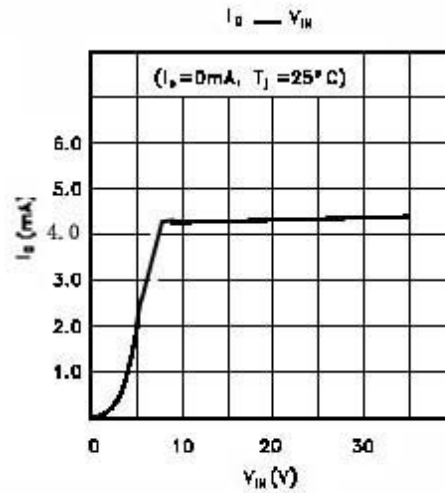
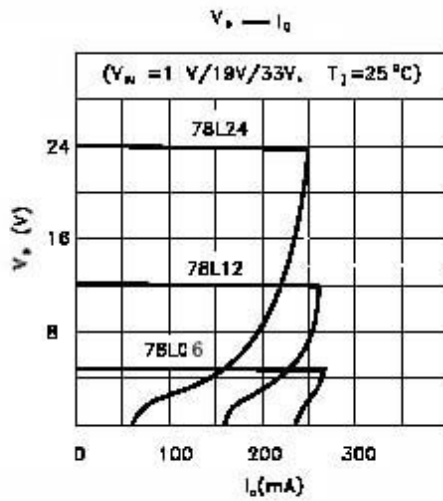
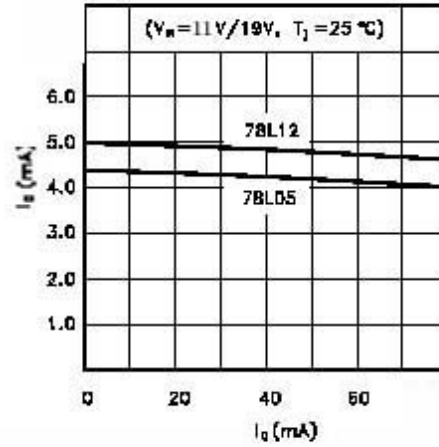
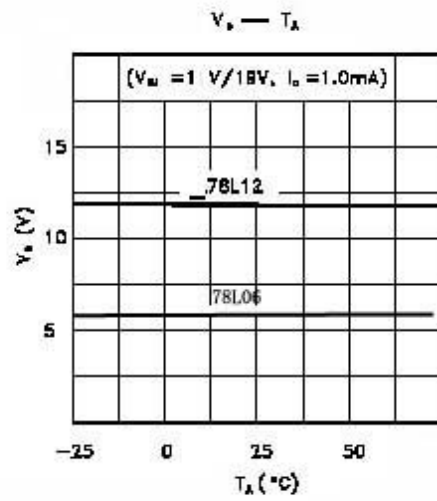

外形尺寸图 / Package Dimensions

TO-92

Unit: mm

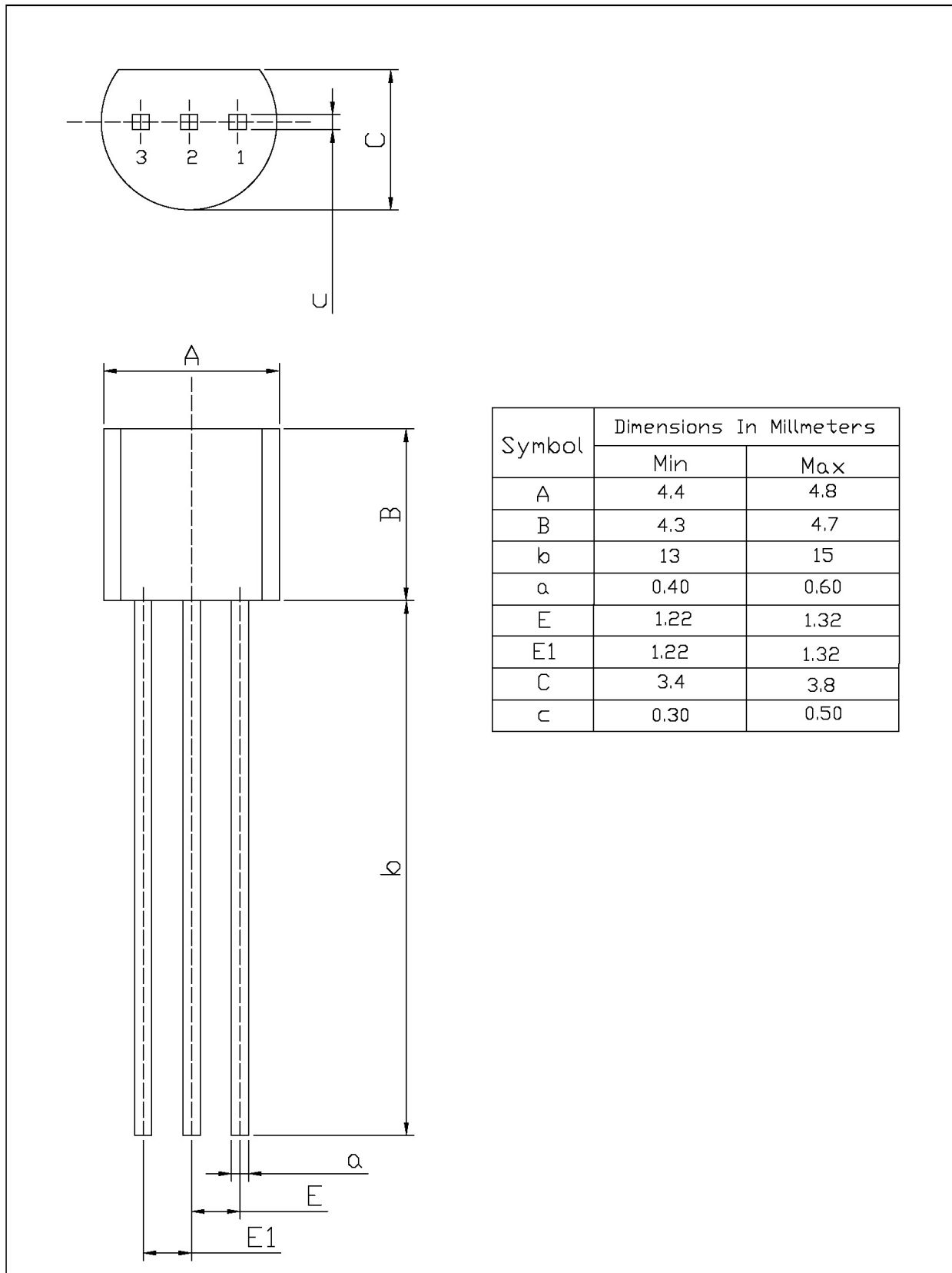

印章说明 / Marking Instructions

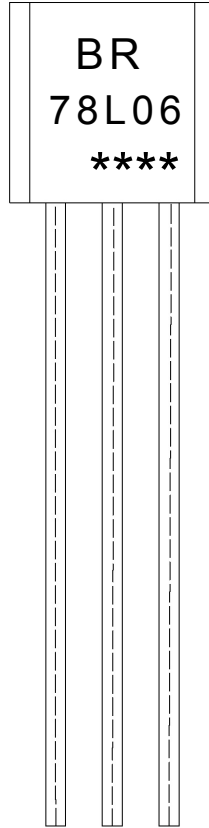

说明：

BR： 为公司代码

78L06： 为产品型号

\*\*\*\*： 为生产批号代码，随生产批号变化。

Note:

BR: Company Code.

78L06: Product Type.

\*\*\*\*: Lot No. Code, code change with Lot No.

**波峰焊温度曲线图(无铅) / Temperature Profile for Dip Soldering(Pb-Free)**

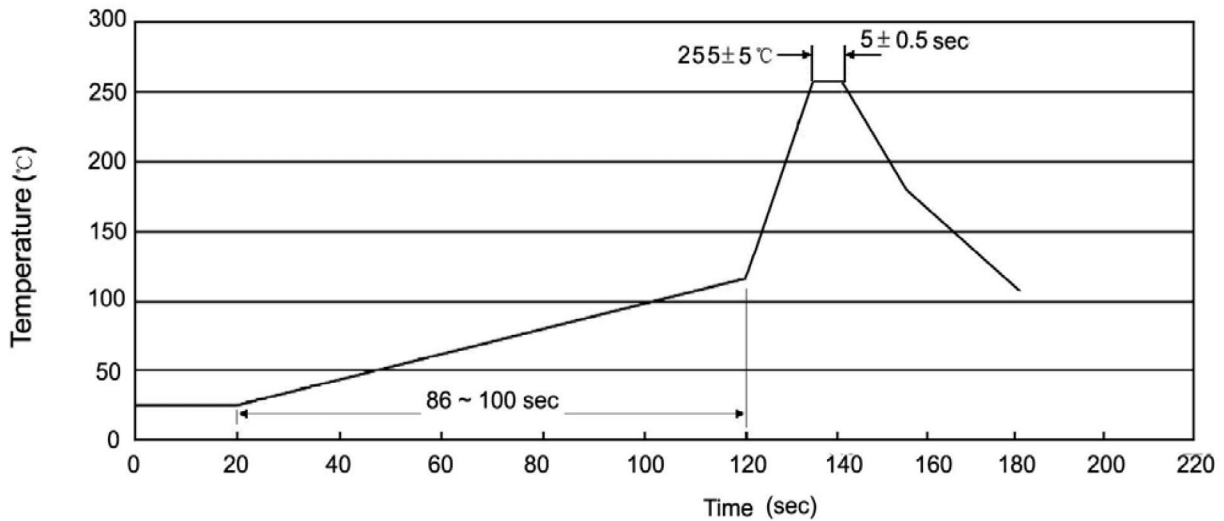

说明：

- 1、预热温度 25~150°C，时间 60~90sec;
- 2、峰值温度 255±5°C，时间持续为 5±0.5sec;
- 3、焊接制程冷却速度为 2~10°C/sec.

Note:

- 1.Preheating:25~150°C, Time:60~90sec.
- 2.Peak Temp.:255±5°C, Duration:5±0.5sec.
3. Cooling Speed: 2~10°C/sec.

**耐焊接热试验条件 / Resistance to Soldering Heat Test Conditions**

温度：270±5°C

时间：10±1 sec.

Temp:270±5°C

Time:10±1 sec

**包装规格 / Packaging SPEC.**

散件包装 / BULK

Package Type 封装形式	Units 包装数量					Dimension 包装尺寸 (unit: mm3)		
	Units/Bag 只/袋	Bags/Inner Box 袋/盒	Units/Inner Box 只/盒	Inner Boxes/Outer Box 盒/箱	Units/Outer Box 只/箱	Bag 袋	Inner Box 盒	Outer Box 箱
TO-92	1,000	10	10,000	5	50,000	135×190	237×172×102	560×245×195
	1,000	10	10,000	10	100,000	135×190	237×172×102	560×245×375

编带包装 / AMMO

Package Type 封装形式	Units 包装数量					Dimension 包装尺寸 (unit: mm3)	
	Units/tape 只/纸带	Tape/Inner Box 纸带/盒	Rows/Inner Box 纸带层/盒	Inner Boxes/Outer Box 盒/箱	Units/Outer Box 只/箱	Inner Box 盒	Outer Box 箱
TO-92	3,000	1	120	10	30,000	328×230×42	小箱 480×346×235, 大箱 547×407×268

**使用说明 / Notices**