

BRCS040N02DP

Rev.A May.-2023

描述 / Descriptions

TO-252 塑封封装 N 沟道场效应管。

N-CHANNEL MOSFET in a TO-252 Plastic Package.

特征 / Features

$V_{DS} (V) = 20V$ $I_D = 95A (V_{GS} = \pm 20V)$

$R_{DS(ON)}@4.5V \leq 4mR (Typ. 3.7mR)$

$R_{DS(ON)}@2.5V \leq 6mR (Typ. 5.5mR)$

$R_{DS(ON)}@2.0V \leq 15mR (Typ. 8mR)$

无卤产品。HF Product.

用途 / Applications

计算、服务器和 POL 中的 DC/DC 转换器，电池保护开关。

DC/DC Converters in Computing, Servers, and POL, Battery protection switch.

内部等效电路 / Equivalent Circuit

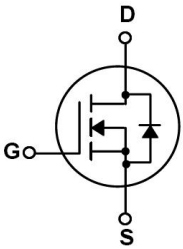

引脚排列 / Pinning

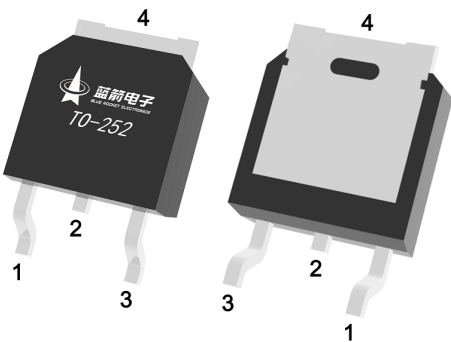

PIN 1 : G

PIN 2 : D

PIN 3 : S

PIN 4 : D

印章代码 / Marking

见印章说明。See Marking Instructions.

极限参数 / Absolute Maximum Ratings(Ta=25°C)

参数 Parameter	符号 Symbol	数值 Rating	单位 Unit
Drain-Source Voltage	V _{DSS}	20	V
Drain Current	I _D (Tc=25°C)	95	A
Drain Current - Pulsed	I _{DM}	212	A
Gate-Source Voltage	V _{GS}	±12	V
Avalanche Current	I _{AS}	24	A
Single Pulsed Avalanche Energy	E _{AS}	201	mJ
Power Dissipation	P _D (Tc=25°C)	55	W
Storage Temperature Range	T _{stg}	-55~150	°C
Thermal Resistance-Junction to Ambient	t ≤ 10s	20	°C/W
	Steady-State	50	
Thermal Resistance-Junction to Case	Steady-State	2.27	

电性能参数 / Electrical Characteristics(Ta=25°C)

参数 Parameter	符号 Symbol	测试条件 Test Conditions	最小值 Min	典型值 Typ	最大值 Max	单位 Unit
Drain-Source Breakdown Voltage	BV _{DSS}	V _{GS} =0V I _D =250μA	20	24		V
Zero Gate Voltage Drain Current	I _{DSS}	V _{DS} =20V V _{GS} =0V			1.0	μA
Gate-Body Leakage Current Forward	I _{GSS}	V _{GS} =±12V V _{DS} =0V			±100	nA
Gate Threshold Voltage	V _{GS(th)}	V _{DS} =V _{GS} I _D =250μA	0.4	0.7	1	V
Static Drain-Source On-Resistance	R _{DS(on)}	V _{GS} =4.5V I _D =15A		3.7	4	mΩ
		V _{GS} =2.5V I _D =10A		5.5	6	
		V _{GS} =2.0V I _D =6.0A		8	15	
Drain-Source Diode Forward Voltage	V _{SD}	V _{GS} =0V I _S =1A			1.25	V
Gate resistance	R _g	V _{GS} =0V V _{DS} =0V, f=1MHz		2.2		Ω
Input Capacitance	C _{iss}	V _{DS} =10V V _{GS} =0V f=1.0MHz		2700		pF
Output Capacitance	C _{oss}			370		
Reverse Transfer Capacitance	C _{rss}			360		
Total Gate Charge	Q _g (4.5V)	V _{GS} =4.5V I _D =20A V _{DS} =10V		31		nC
Gate Source Charge	Q _{gs}			5.2		
Gate Drain Charge	Q _{gd}			8		

电性能参数 / Electrical Characteristics(Ta=25°C)

参数 Parameter	符号 Symbol	测试条件 Test Conditions	最小值 Min	典型值 Typ	最大值 Max	单位 Unit
Turn-On Delay Time	$t_{d(on)}$	$V_{GS}=10V$ $V_{DS}=10V$ $R_L=0.5\Omega$ $R_{GEN}=3\Omega$		7.5		ns
Turn-On Rise Time	t_r			15		
Turn-Off Delay Time	$t_{d(off)}$			72		
Turn-Off Fall Time	t_f			21		

电参数曲线图 / Electrical Characteristic Curve

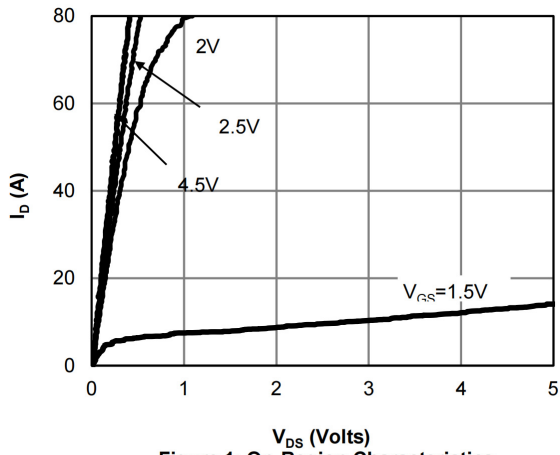

Figure 1: On-Region Characteristics

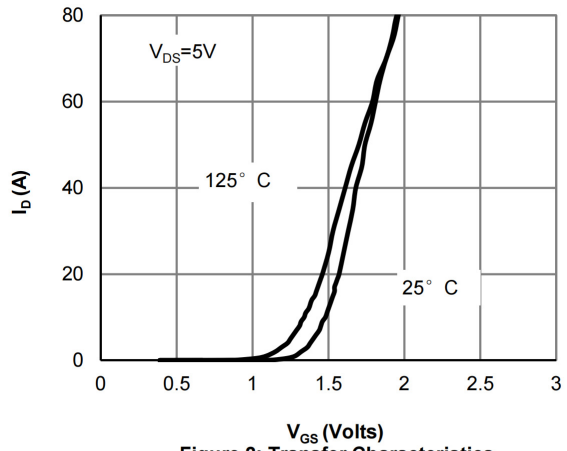

Figure 2: Transfer Characteristics

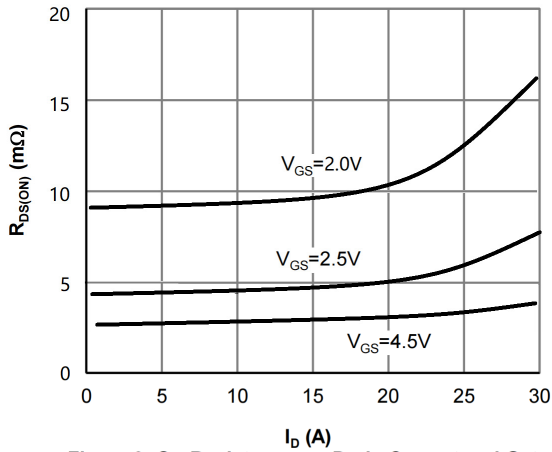

Figure 3: On-Resistance vs. Drain Current and Gate Voltage

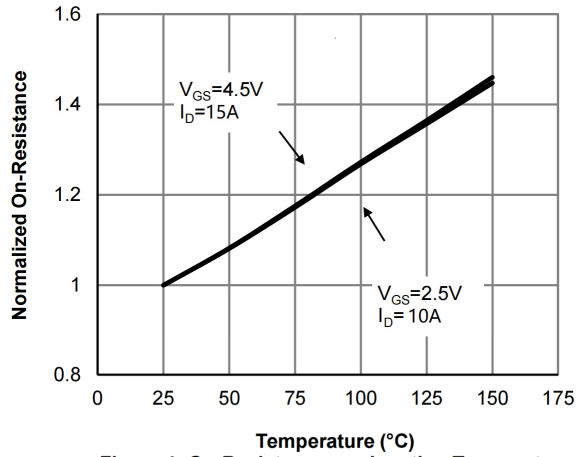

Figure 4: On-Resistance vs. Junction Temperature

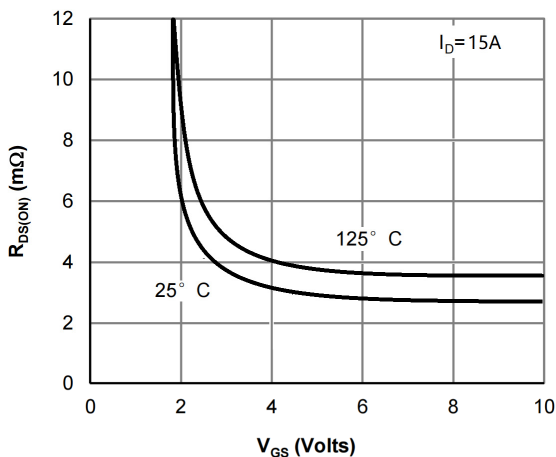

Figure 5: On-Resistance vs. Gate-Source Voltage

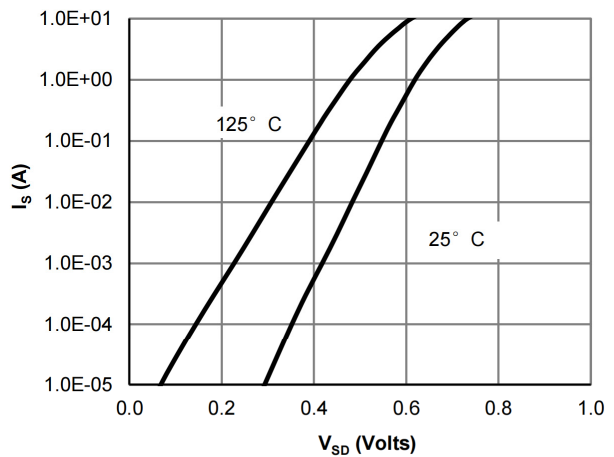

Figure 6: Body-Diode Characteristics

电参数曲线图 / Electrical Characteristic Curve

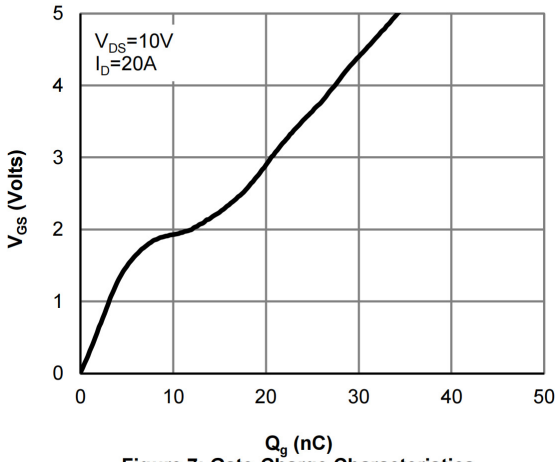

Figure 7: Gate-Charge Characteristics

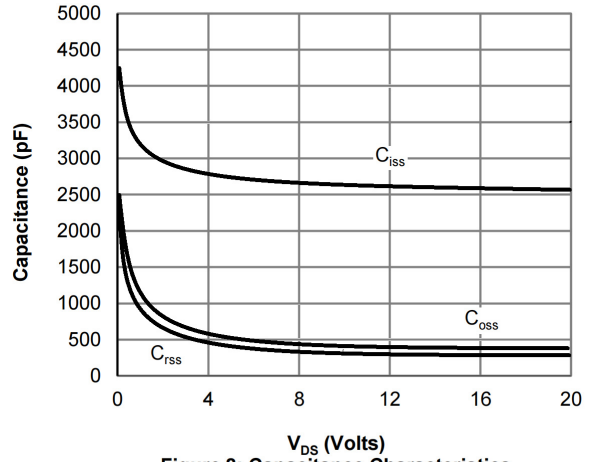

Figure 8: Capacitance Characteristics

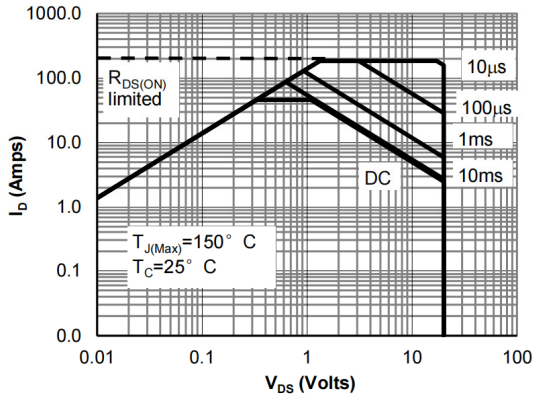

Figure 9: Maximum Forward Biased Safe Operating Area
 $V_{GS} > \text{or equal to } 2.5V$

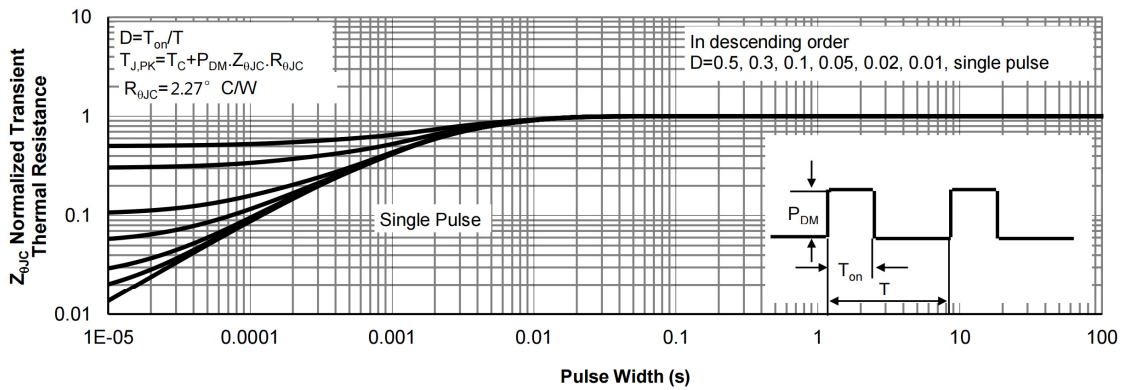
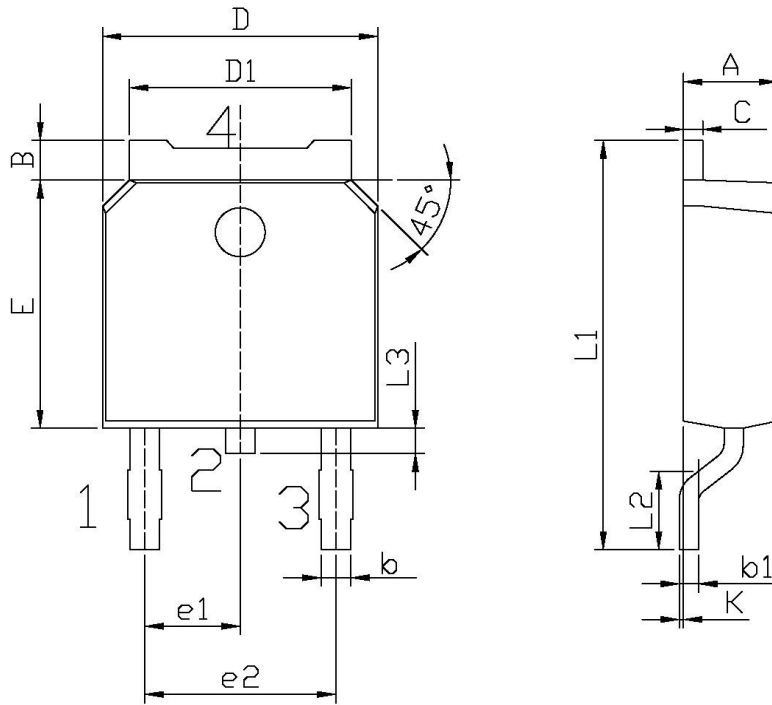

Figure 10: Normalized Maximum Transient Thermal Impedance

外形尺寸图 / Package Dimensions



单位: mm

Symbol	Dimensions In Millimeters		Symbol	Dimensions In Millimeters	
	Min	Max		Min	Max
A	2.20	2.40	E	5.95	6.25
B	0.95	1.25	e1	2.24	2.34
b	0.70	0.90	e2	4.43	4.73
b1	0.45	0.55	L1	9.85	10.35
C	0.45	0.55	L2	1.70	2.00
D	6.45	6.75	L3	0.60	0.90
D1	5.10	5.50	K	0.00	0.10

TO-252

印章说明 / Marking Instructions

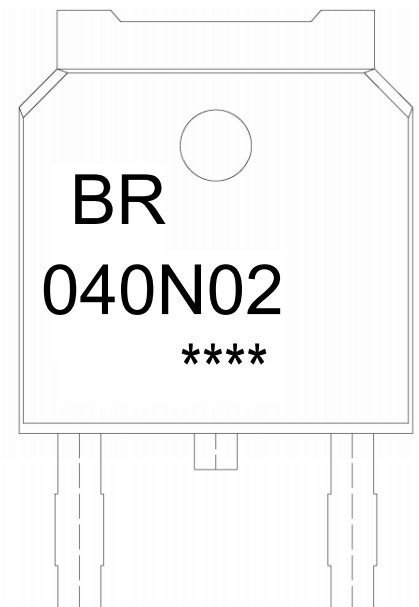

说明：

BR： 为公司代码

040N02： 为型号代码

****： 为生产批号代码，随生产批号变化

Note:

BR: Company Code

040N02: Product Type Code

****: Lot No. Code, code change with Lot No

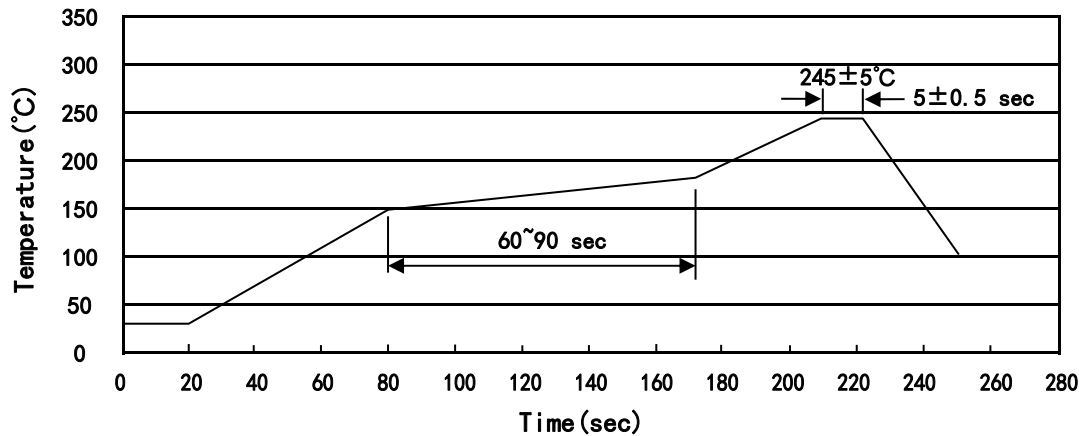
回流焊温度曲线图(无铅) / Temperature Profile for IR Reflow Soldering(Pb-Free)

说明：

- 1、预热温度 150~180°C，时间 60~90sec;
- 2、峰值温度 245±5°C，时间持续为 5±0.5sec;
- 3、焊接制程冷却速度为 2~10°C/sec.

Note:

- 1.Preheating:150~180°C, Time:60~90sec.
- 2.Peak Temp.:245±5°C, Duration:5±0.5sec.
3. Cooling Speed: 2~10°C/sec.

耐焊接热试验条件 / Resistance to Soldering Heat Test Conditions

温度：260±5°C

时间：10±1 sec.

Temp.:260±5°C

Time:10±1 sec

包装规格 / Packaging SPEC.

卷盘包装 / REEL

Package Type 封装形式	Units 包装数量					Dimension 包装尺寸 (unit: mm ³)		
	Units/Reel 只/卷盘	Reels/Inner Box 卷盘/盒	Units/Inner Box 只/盒	Inner Boxes/Outer Box 盒/箱	Units/Outer Box 只/箱	Reel	Inner Box 盒	Outer Box 箱
TO-252	2,500	2	5,000	6	30,000	13" ×16	360×360×50	380×335×366

套管包装 / TUBE

Package Type 封装形式	Units 包装数量					Dimension 包装尺寸 (unit: mm ³)		
	Units/Tube 只/套管	Tubes/Inner Box 套管/盒	Units/Inner Box 只/盒	Inner Boxes/Outer Box 盒/箱	Units/Outer Box 只/箱	Tube 套管	Inner Box 盒	Outer Box 箱
TO-251/252	75	48	3,600	5	18,000	526×20.5×5.25	555×164×50	575×290×180

使用说明 / Notices