

BRCS055N03YM

Rev.B May.-2024

描述 / Descriptions

PDFN5×6A 塑封封装双 N 沟道场效应管。

Dual N-CHANNEL MOSFET in a PDFN5×6A Plastic Package.

特征 / Features

$V_{DS}(V)=30V$ $I_D=52A$

$R_{DS(ON)}@10V < 5.5m\Omega$ (Typ. 5.2 m Ω)

$R_{DS(ON)}@4.5V < 9.5m\Omega$ (Typ. 7.6 m Ω)

无卤产品。HF Product.

用途 / Applications

PWM 应用、负载开关、电源管理、LED 调光。

PWM Application, Load Switch, Power Management, Dimming LED.

内部等效电路 / Equivalent Circuit

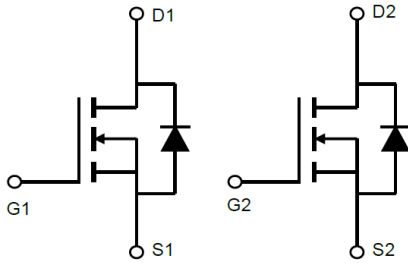

引脚排列 / Pinning

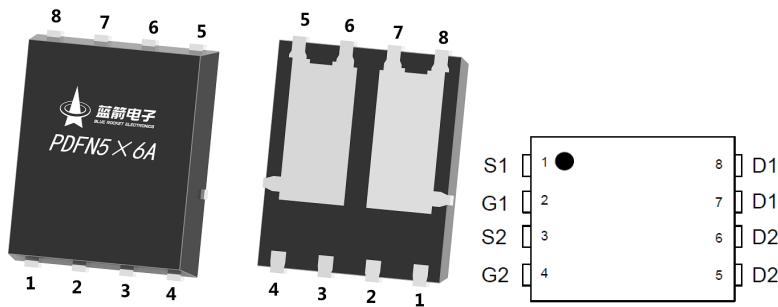

印章代码 / Marking

见印章说明。

See Marking Instructions.

极限参数 / Absolute Maximum Ratings(Ta=25°C)

参数 Parameter	符号 Symbol	数值 Rating	单位 Unit
Drain-Source Voltage	V _{DSS}	30	V
Gate-Source Voltage	V _{GS}	±20	V
Continuous Drain Current	I _D (T _C =25°C)	52	A
Pulsed Drain Current	I _{DM}	136	A
Power Dissipation	P _D (T _C =25°C)	26.5	W
Junction and Storage Temperature Range	T _J , T _{STG}	-55 to +150	°C
Maximum Junction-to-Ambient	R _{θJA} (≤10s)	43	°C/W
Maximum Junction-to-Ambient	R _{θJA} (Steady-State)	62	°C/W
Maximum Junction-to-Case	R _{θJC} (Steady-State)	4.7	°C/W

电性能参数 / Electrical Characteristics(Ta=25°C)

参数 Parameter	符号 Symbol	测试条件 Test Conditions	最小值 Min	典型值 Typ	最大值 Max	单位 Unit
Drain-Source Breakdown Voltage	BV _{DSS}	V _{GS} =0V I _D =250μA	30	35		V
Zero Gate Voltage Drain Current	I _{DSS}	V _{DS} =30V V _{GS} =0V			1	μA
Gate-Body leakage current	I _{GSS}	V _{GS} =±20V V _{DS} =0V			±100	nA
Gate Threshold Voltage	V _{GS(th)}	V _{DS} =V _{GS} I _D =250μA	1.0	1.8	2.5	V
Static Drain-Source On-Resistance	R _{DS(on)}	V _{GS} =10V I _D =20A		5.2	5.5	mΩ
		V _{GS} =4.5V I _D =10A		7.6	9.5	mΩ
Diode Forward Voltage	V _{SD}	V _{GS} =0V I _S =1.0A			1.2	V
Input Capacitance	C _{iss}	V _{DS} =25V V _{GS} =0V f=1.0MHz		2030		pF
Output Capacitance	C _{oss}			168		pF
Reverse Transfer Capacitance	C _{rss}			163		pF
Gate resistance	R _g	V _{DS} =0V V _{GS} =0V f=1.0MHz		3		Ω
Total Gate Charge	Q _{g(10V)}	V _{GS} =10V V _{DS} =15V I _D =20A		40		nC
Total Gate Charge	Q _{g(4.5V)}			22		nC
Gate-Source Charge	Q _{gs}			11		nC
Gate-Drain Charge	Q _{gd}			5		nC

电性能参数 / Electrical Characteristics(Ta=25℃)

参数 Parameter	符号 Symbol	测试条件 Test Conditions	最小值 Min	典型值 Typ	最大值 Max	单位 Unit
Turn-On Delay Time	$t_{d(on)}$	$V_{DS}=15\text{ V}$ $V_{GS}=10\text{ V}$ $R_L=0.75\Omega$ $R_{GEN}=3\Omega$		11		ns
Turn-On Rise Time	t_r			14		ns
Turn-Off Delay Time	$t_{d(off)}$			38		ns
Turn-Off Fall Time	t_f			10		ns

电参数曲线图 / Electrical Characteristic Curve

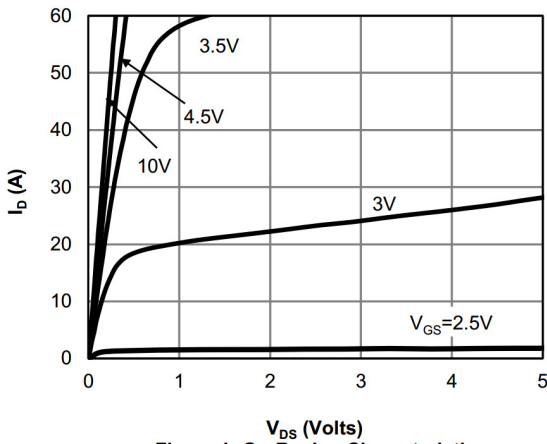

Figure 1: On-Region Characteristics

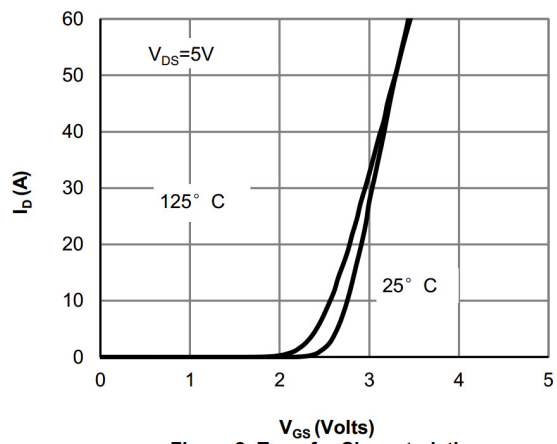

Figure 2: Transfer Characteristics

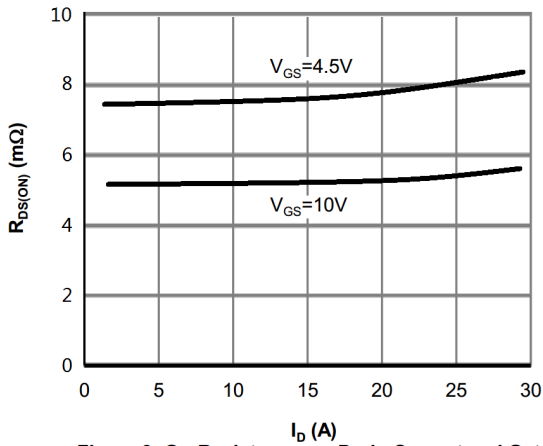

Figure 3: On-Resistance vs. Drain Current and Gate Voltage

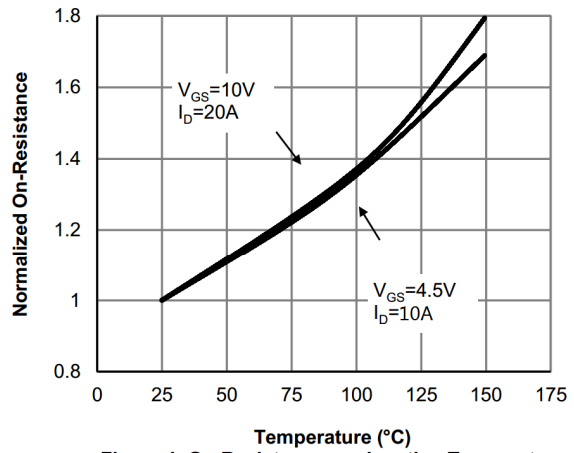

Figure 4: On-Resistance vs. Junction Temperature

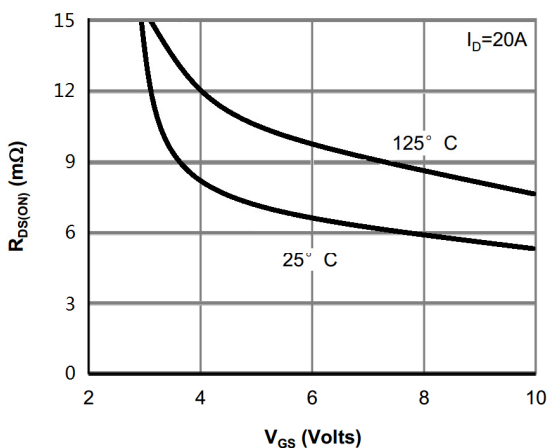

Figure 5: On-Resistance vs. Gate-Source Voltage

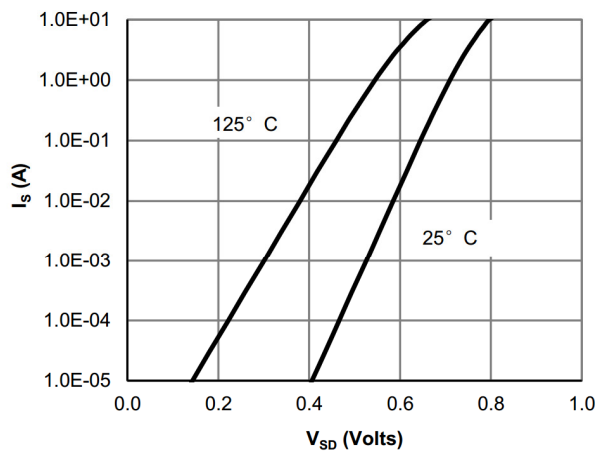

Figure 6: Body-Diode Characteristics

电参数曲线图 / Electrical Characteristic Curve

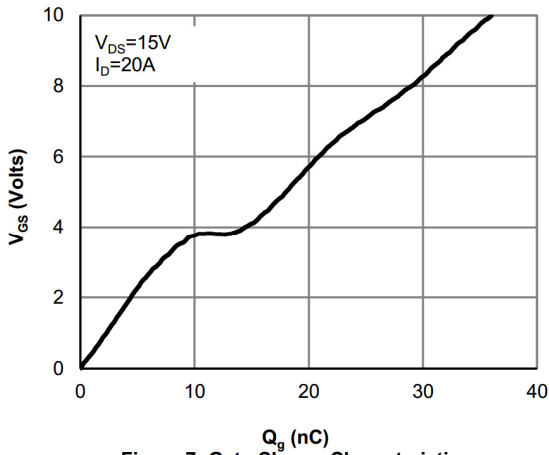

Figure 7: Gate-Charge Characteristics

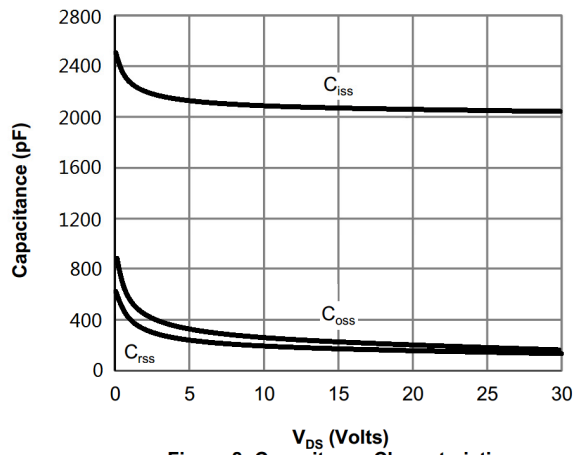

Figure 8: Capacitance Characteristics

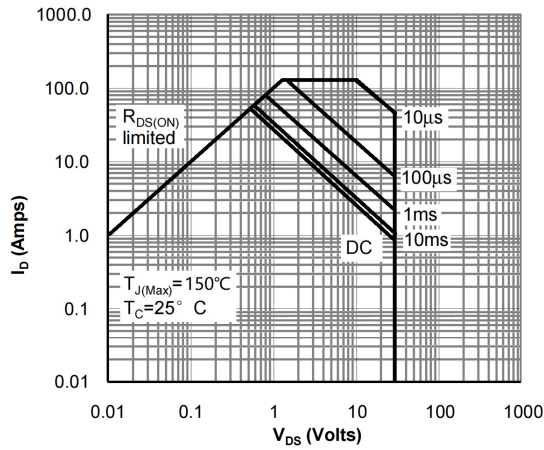

Figure 9: Maximum Forward Biased Safe Operating Area

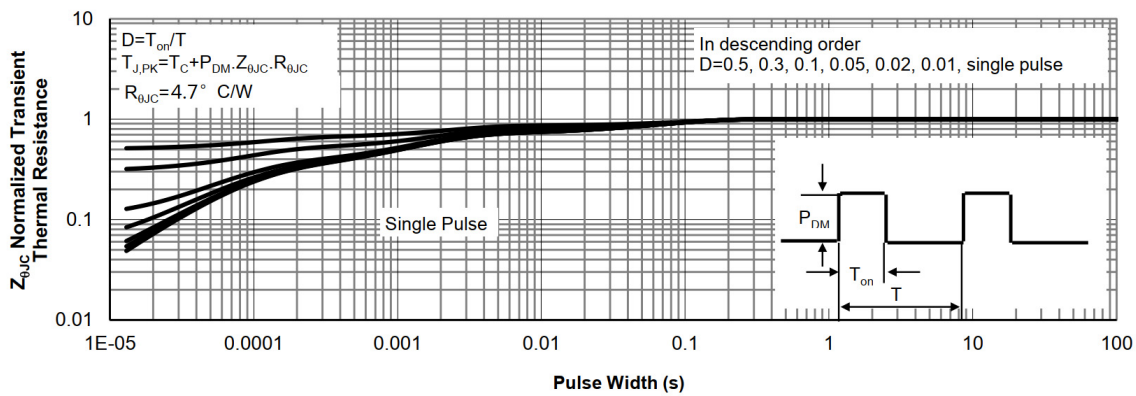

Figure 10: Normalized Maximum Transient Thermal Impedance

BRCS055N03YM

Rev.B May.-2024

外形尺寸图 / Package Dimensions

PDFN5 X6A

Unit:mm

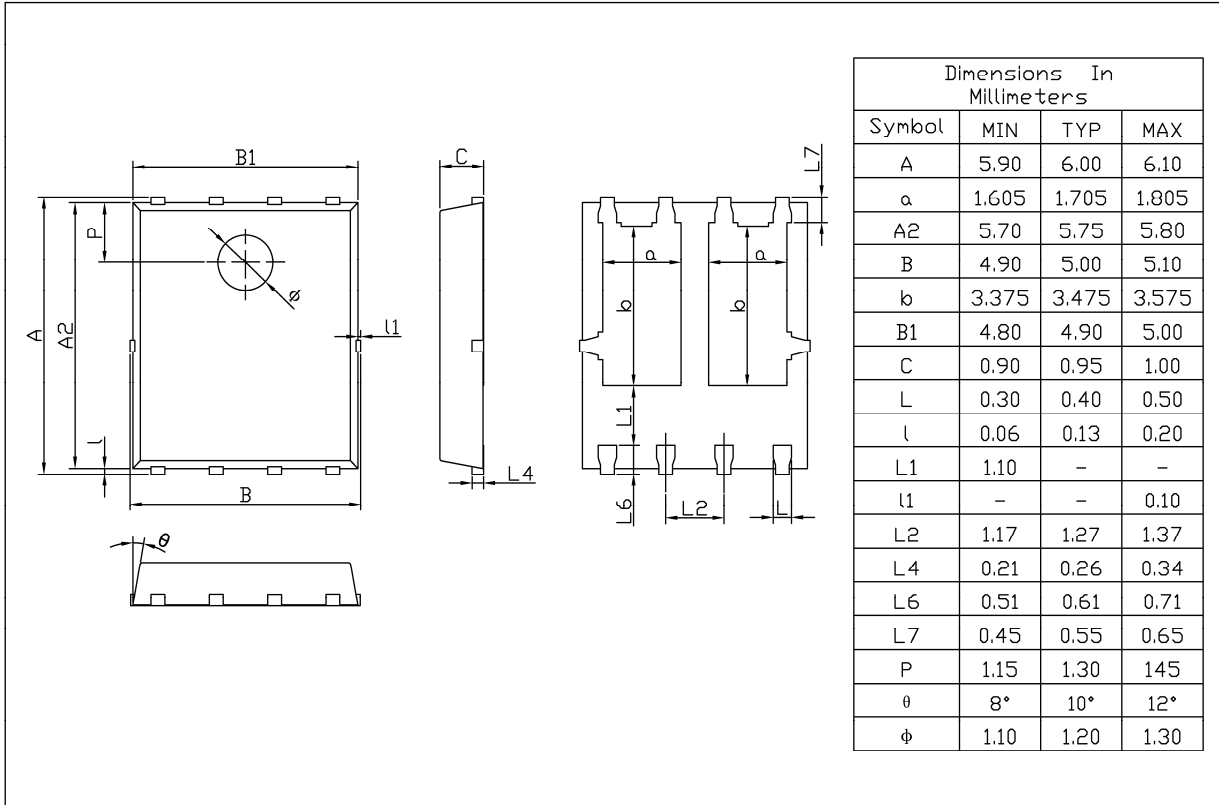

Rev.01 202209

印章说明 / Marking Instructions

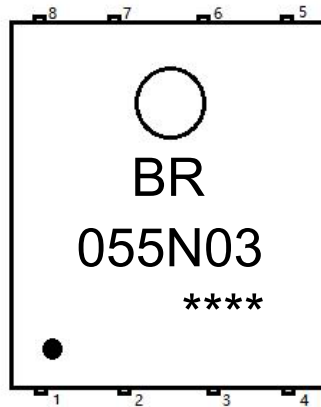

说明：

BR： 为公司代码

055N03： 为型号代码

****： 为生产批号代码，随生产批号变化

Note：

BR： Company Code

055N03： Product Type Code

****: Lot No. Code, code change with Lot No

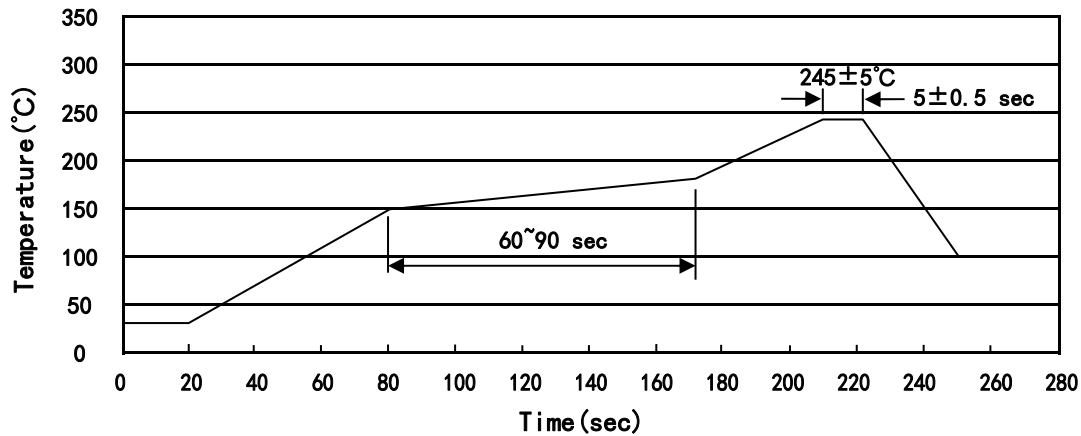
回流焊温度曲线图(无铅) / Temperature Profile for IR Reflow Soldering(Pb-Free)

说明：

- 1、预热温度 150~180°C，时间 60~90sec;
- 2、峰值温度 245±5°C，时间持续为 5±0.5sec;
- 3、焊接制程冷却速度为 2~10°C/sec.

Note:

- 1.Preheating:150~180°C, Time:60~90sec.
- 2.Peak Temp.:245±5°C, Duration:5±0.5sec.
3. Cooling Speed: 2~10°C/sec.

耐焊接热试验条件 / Resistance to Soldering Heat Test Conditions

温度：260±5°C

时间：10±1 sec.

Temp.:260±5°C

Time:10±1 sec

包装规格 / Packaging SPEC.

卷盘包装 / REEL

Package Type 封装形式	Units 包装数量					Dimension 包装尺寸 (unit: mm ³)		
	Units/Reel 只/卷盘	Reels/Inner Box 卷盘/盒	Units/Inner Box 只/盒	Inner Boxes/Outer Box 盒/箱	Units/Outer Box 只/箱	Reel	Inner Box 盒	Outer Box 箱
PDFN5×6A	5,000	2	10,000	6	60,000	13"×12	360×360×50	380×335×366

使用说明 / Notices