

BRCS080N10SHRA

Rev.B Sep.-2022

描述 / Descriptions

TO-220 塑封封装 N 沟道场效应管。
N-CHANNEL MOSFET in a TO-220 Plastic Package.

特征 / Features

低电阻,开关速度快。
Ultra Low On-Resistance,fast switching.

用途 / Applications

该器件适用于高效电源模块, 主动式 PFC 电路和基于半桥拓扑结构的电子节能灯。
These devices are well suited for high efficient switched mode power supplies, Active power factor correction, electronic lamp ballast based on half bridge topology.

内部等效电路 / Equivalent Circuit

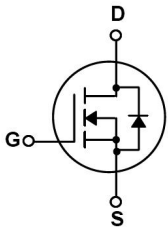

引脚排列 / Pinning

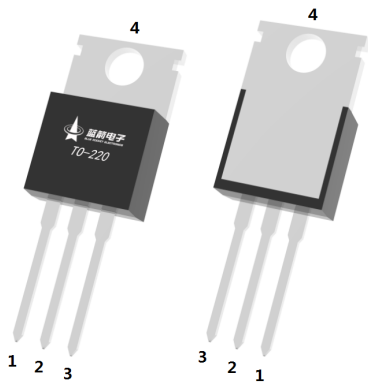

PIN1 : G PIN 2、 4 : D PIN 3 : S

印章代码 / Marking

见印章说明。 See Marking Instructions.

极限参数 / Absolute Maximum Ratings(Ta=25°C)

参数 Parameter	符号 Symbol	数值 Rating	单位 Unit
Drain-Source Voltage	V _{DSS}	100	V
Drain Current	I _D (Tc=25°C)	73	A
Pulsed Drain Current	I _{DM}	190	A
Gate-Source Voltage	V _{GS}	±20	V
Single Pulsed Avalanche Energy L=0.5mH	E _{AS}	78.8	mJ
Avalanche Current	I _{AS}	15	A
Total Power Dissipation	P _D (Tc=25°C)	90	W
Junction and Storage Temperature Range	T _J , T _{STG}	-55 to 150	°C
Thermal Resistance-Junction to Ambient	t ≤ 10s	15	°C/W
	Steady-State	60	
Thermal Resistance-Junction to Case	Steady-State	1.4	

电性能参数 / Electrical Characteristics(Ta=25°C)

参数 Parameter	符号 Symbol	测试条件 Test Conditions	最小值 Min	典型值 Typ	最大值 Max	单位 Unit
Drain-Source Breakdown Voltage	BV _{DSS}	V _{GS} =0V I _D =250μA	100	108		V
Zero Gate Voltage Drain Current	I _{DSS}	V _{DS} =100V V _{GS} =0V			1	μA
Gate-Body Leakage Current Forward	I _{GSS}	V _{GS} =±20V V _{DS} =0V			±100	nA
Gate Threshold Voltage	V _{GS(th)}	V _{DS} =V _{GS} I _D =250μA	2	2.7	4	V
Static Drain-Source On-Resistance	R _{DS(on)}	V _{GS} =10V I _D =20A		7.2	8.5	mΩ
	R _{DS(on)}	V _{GS} =6V I _D =10A		9.5	12	mΩ
Forward On Voltage	V _{SD}	V _{GS} =0V I _S =1A			1.2	V
Gate resistance	R _g	f=1MHz		2		Ω
Input Capacitance	C _{iss}	V _{DS} =25V V _{GS} =0V f=1MHz		2250		pF
Output Capacitance	C _{oss}			1180		
Reverse Transfer Capacitance	C _{rss}			115		

电性能参数 / Electrical Characteristics(Ta=25°C)

参数 Parameter	符号 Symbol	测试条件 Test Conditions	最小值 Min	典型值 Typ	最大值 Max	单位 Unit
Total Gate Charge	$Q_g(10V)$	$V_{GS}=10V$ $V_{DS}=50V$ $I_D=20A$		37		nC
Gate Source Charge	Q_{gs}			11.5		
Gate Drain Charge	Q_{gd}			5		
Turn-On Delay Time	$t_{d(on)}$	$V_{GS}=10V$ $V_{DS}=50V$ $R_L=2.5\Omega$ $R_{GEN}=3\Omega$		13		ns
Turn-On Rise Time	t_r			8.5		
Turn-Off Delay Time	$t_{d(off)}$			29		
Turn-Off Fall Time	t_f			4		

电参数曲线图 / Electrical Characteristic Curve

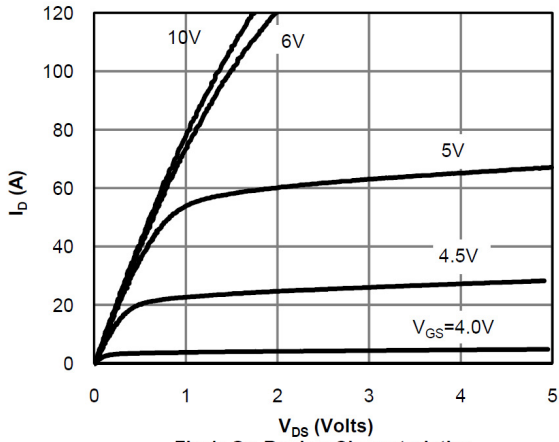

Fig 1: On-Region Characteristics

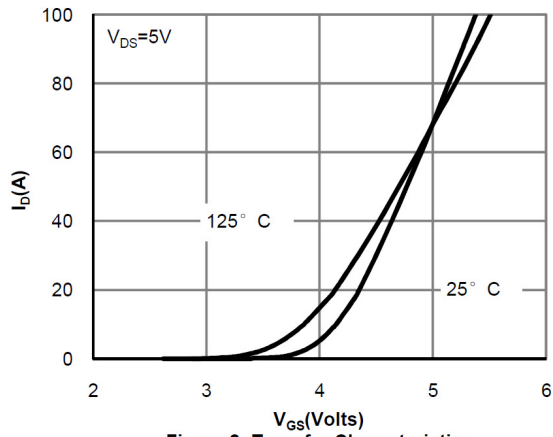

Figure 2: Transfer Characteristics

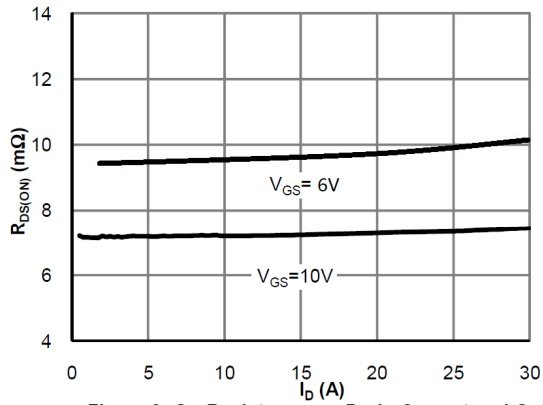

Figure 3: On-Resistance vs. Drain Current and Gate Voltage

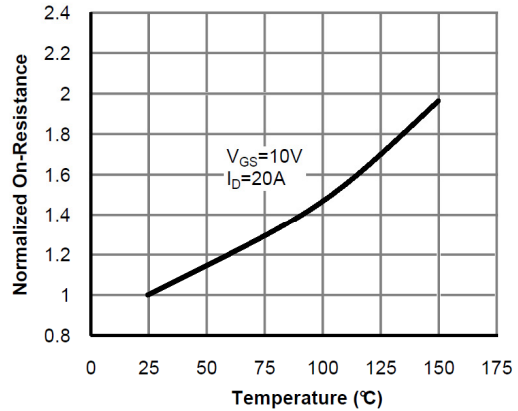

Figure 4: On-Resistance vs. Junction Temperature

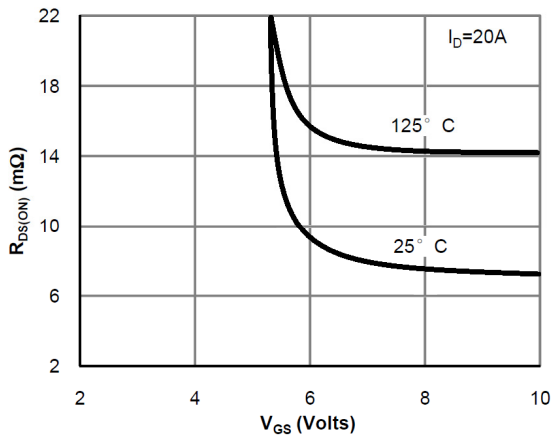

Figure 5: On-Resistance vs. Gate-Source Voltage

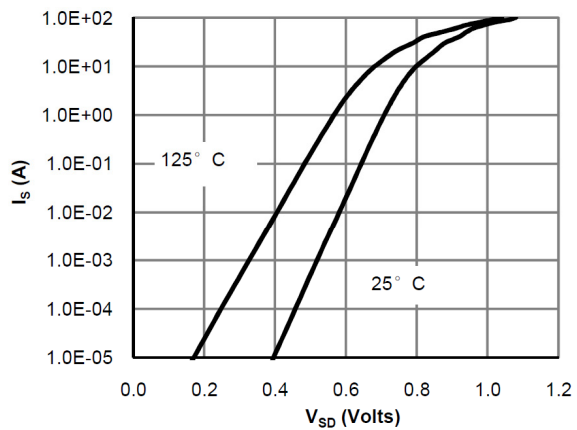

Figure 6: Body-Diode Characteristics

电参数曲线图 / Electrical Characteristic Curve

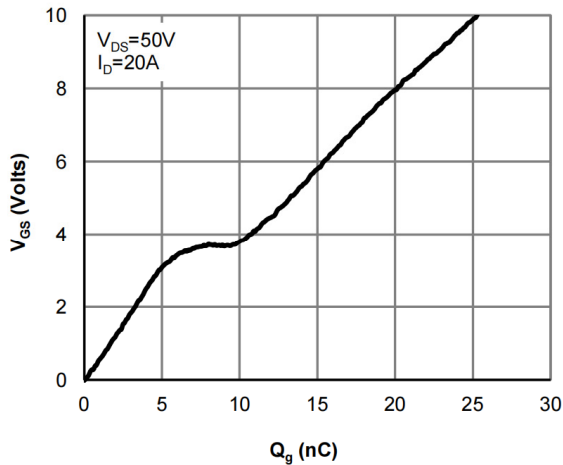

Figure 7: Gate-Charge Characteristics

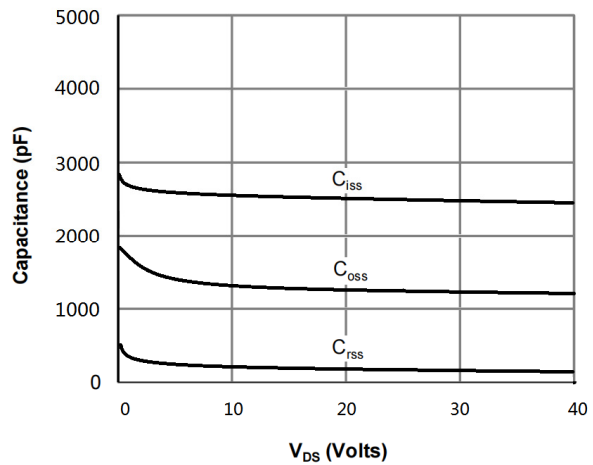

Figure 8: Capacitance Characteristics

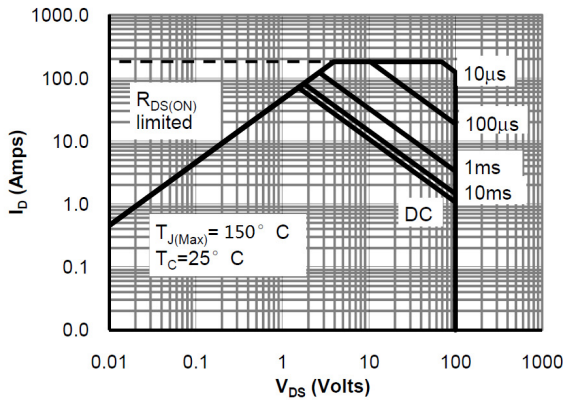

Figure 9: Maximum Forward Biased Safe Operating Area

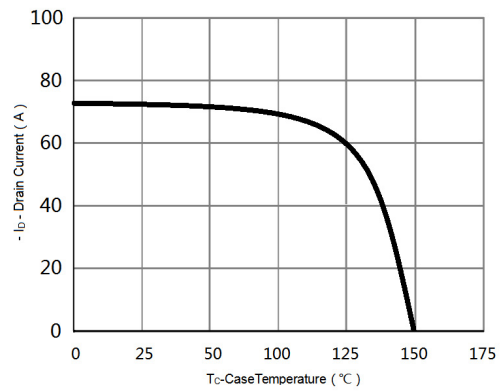

Figure 10: Maximum Continuous Drain Current Vs Case Temperature

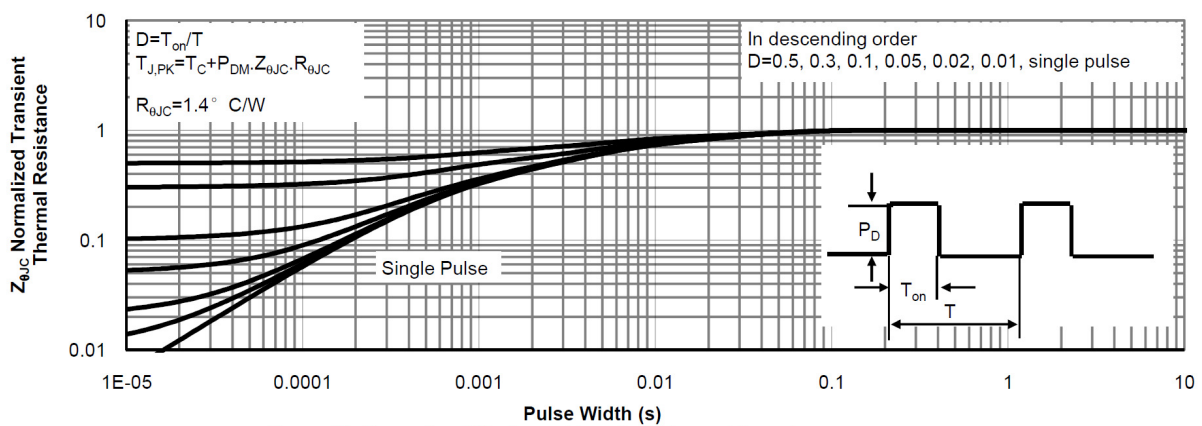
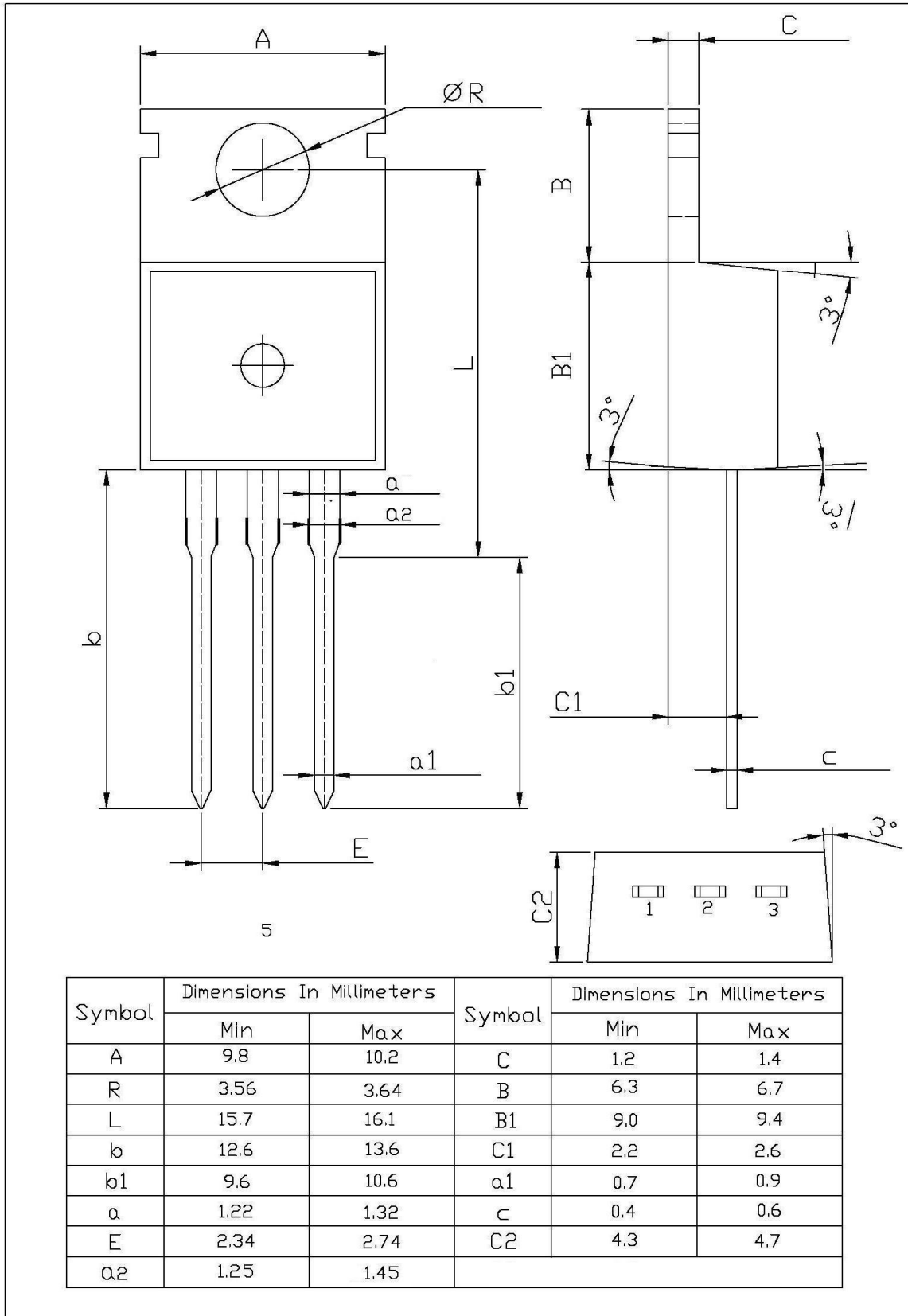

Figure 11: Normalized Maximum Transient Thermal Impedance

外形尺寸图 / Package Dimensions

T0-220

单位: mm



印章说明 / Marking Instructions

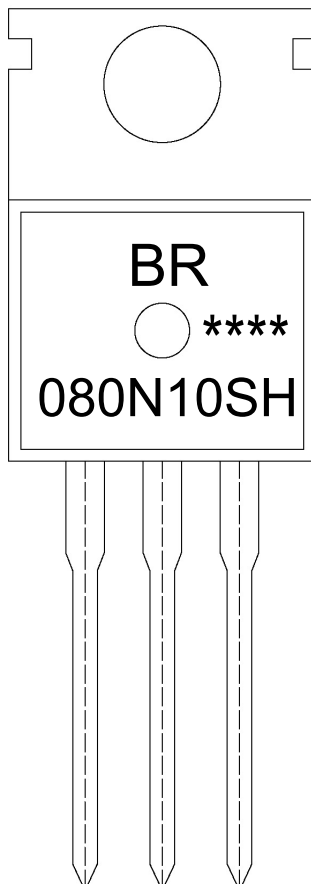

说明：

BR： 为公司代码

080N10SH： 为型号代码

****： 为生产批号代码，随生产批号变化

Note:

BR: Company Code

080N10SH: Product Type

****: Lot No. Code, code change with Lot No

波峰焊温度曲线图(无铅) / Temperature Profile for Dip Soldering(Pb-Free)

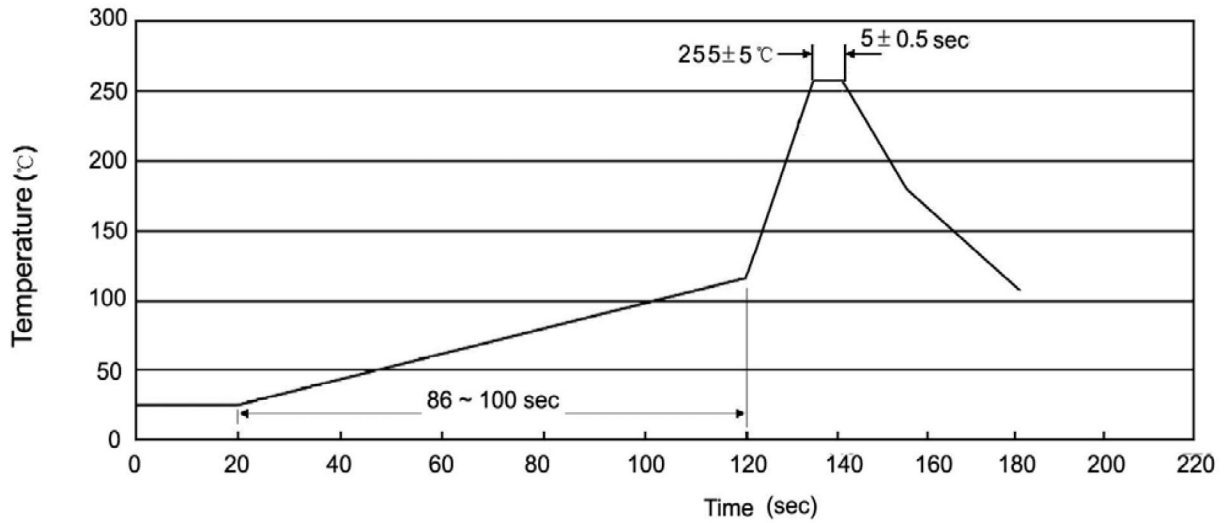

说明：

- 1、预热温度 25 ~ 150°C，时间 60 ~ 90sec；
- 2、峰值温度 255±5°C，时间持续为 5±0.5sec；
- 3、焊接制程冷却速度为 2 ~ 10°C/sec.

Note:

- 1.Preheating:25~150°C, Time:60~90sec.
- 2.Peak Temp.:255±5°C, Duration:5±0.5sec.
3. Cooling Speed: 2~10°C/sec.

耐焊接热试验条件 / Resistance to Soldering Heat Test Conditions

温度：270±5°C 时间：10±1 sec. Temp.:270±5°C Time:10±1 sec

包装规格 / Packaging SPEC.

散件包装 / BULK

Package Type 封装形式	Units 包装数量					Dimension 包装尺寸 (unit: mm ³)		
	Units/Bag 只/袋	Bags/Inner Box 袋/盒	Units/Inner Box 只/盒	Inner Boxes/Outer Box 盒/箱	Units/Outer Box 只/箱	Bag 袋	Inner Box 盒	Outer Box 箱
TO-220/F	200	10	2,000	5	10,000	135×190	237×172×102	560×245×195

套管包装 / TUBE

Package Type 封装形式	Units 包装数量					Dimension 包装尺寸 (unit: mm ³)		
	Units/Tube 只/套管	Tubes/Inner Box 套管/盒	Units/Inner Box 只/盒	Inner Boxes/Outer Box 盒/箱	Units/Outer Box 只/箱	Tube 套管	Inner Box 盒	Outer Box 箱
TO-220/F	50	20	1,000	5	5,000	532×31.4×5.5	555×164×50	575×290×180

使用说明 / Notices